

Installation and Operating Instructions

Video Intercom Kit
Model No. **VL-VQS300SX**



Thank you for purchasing a Panasonic product.

Please follow all instructions in this document and save it for future reference.

Carefully read the information found in the section titled "Important safety information" in particular.

The terms Door panel, Video doorbell, and outdoor station used in this document refer to the Door Station.

The terms Indoor monitor and Monitor used in this document refer to the Room Monitor.

This system is not designed to provide complete protection from property loss. To the maximum extent permitted by applicable law, Panasonic will not be held responsible for any damage incurred as a result of property loss.

Note to the installer

- **This document includes instructions for both installation and operation. See the section titled "Installation" for installation instructions.**
- Please read this document carefully, and install the product safely and correctly by following the instructions.
- Only use attachments/accessories specified by the manufacturer.
- The installation shall be carried out in accordance with all applicable installation rules.

Table of Contents

1. Technical Specifications	1
2. Packing Contents.....	2
3. Name and Functions of Each Part	4
4. Connection Diagram.....	6
4.1 System Layout.....	6
4.2 Wiring Diagram.....	7
5. Installation.....	8
6. Operation Description.....	9
6.1 Main Screen	9
6.2 Intercom Function.....	10
6.2.1 Record.....	11
6.2.2 Intercom	11
6.2.3 Setting	12
6.2.4 SOS Settings.....	14
6.2.5 Visitor Call from video door bell	14
6.3 Contact	15
6.4 Message Function	15
6.5 Monitor Function.....	16
6.6 Alarm Function	17
6.7 Motion detect.....	19
6.8 Record	19
6.9 Do not disturb	20
6.10 Main Setting page	20
6.11 Engineering Setting	21
6.11.1 System reset	21
6.11.2 Engineering password.....	22
6.11.3 Device information.....	22
6.11.4 SIP register.....	22
6.11.5 Self Unlock mode	23
6.11.6 Unlock Time.....	23
7. Wifi Function.....	24
7.1 Add device.....	24
7.2 Control the Monitor through the APP	24
7.3 Unbind the Monitor to the APP.....	24
8. Web Client Operation.....	24
8.1 Login the Client	24
8.2 Local Configuration Page.....	25
8.3 SIP Configuration Page.....	25
8.4 User Management Page	26
8.5 Maintenance Page	27
8.6 Local Address Page (Only for villa mode).....	27

Important safety information

To prevent severe injury or loss of life or property, and to ensure proper and safe operation of your product, read this section carefully before using the product.



Preventing fire, electric shock, and short circuits

- **Leave installation work to the dealer. Installation work requires technical knowledge and experience. Electrical connection work should be performed by certified personnel only. Failure to observe this may cause fire, electric shock, injury, or damage to the product. Consult the dealer.**

- Follow the below instructions about the power supply. *1

- Use only the included DC adaptor CS-1201000.<*>

<*> This product complies with the IEEE 802.3af Power-over-Ethernet (PoE) standard. If PoE is available on your network, this product can receive the necessary power from the network through the ethernet cable and no DC adaptor is needed. If PoE is not available, you will need to connect a DC adaptor to the product.

Required PoE-connected devices (user supplied) specifications

- A switching hub or power supply device that supports PoE (compliant with IEEE 802.3af)
- Complies with safety standard IEC60950-1 or IEC62368-1

Refer to the documentation included with the PoE-connected device for details.

If unsure whether it complies with safety standards, please contact the manufacturer of the switching hub or power supply device.

Required DC adaptor (user supplied) specifications

- Complies with safety standard BIS certification
- INPUT: AC 100 V-240 V, 50/60 Hz
- OUTPUT: DC 12 V, 1.5 A-2.0 A, 18 W-24 W

Refer to the documentation included with the DC adaptor for details.

If unsure whether it complies with safety standards, please contact the manufacturer of the DC adaptor.

If devices other than above are connected, safety and performance cannot be guaranteed.

- Do not place objects on the cables. Install the product where no one can step or trip on the cables. *1
- Do not allow the cables to be excessively pulled, bent or placed under heavy objects. *1
- Insert the DC cable plug or DC adaptor firmly all the way into the terminals or power outlet. If they are not inserted all the way, heat may be generated. *1
- Never touch the DC cable plug or DC adaptor with wet hands. *1
- Do not disassemble or modify the product. Refer servicing to an authorized service center when service is required. Disassembling the product or manipulating the product in a way not described in the documentation may expose you to dangerous voltages and other risks.
- Do not touch the product, cables, DC cable plug or DC adaptor during an electrical storm. There may be remote risk of electric shock from lightning. *1

- Never install wiring during a lightning storm.
- Do not connect non-specified devices.
- Do not connect a cable to a terminal that is not specified in this document. *1
- When opening holes in walls for installation or wiring, or when securing the cable, make sure you do not damage existing wiring and ductwork.
- Do not make any wiring connections when the power outlet is turned on.
- Do not install the product in the following places:
 - Places where the product may be splashed with water or chemicals
 - Places where there is a high concentration of dust or high humidity
- Do not expose the product to direct sunlight. *2
- Do not push any objects through the openings of the product.
- If any of the following conditions occur, disconnect the Ethernet (LAN) cable from the product, disconnect the DC adaptor from the power outlet, and then refer servicing to an authorized service center. *1
 - The product emits smoke, an abnormal smell or makes unusual noise
 - The cables are damaged or frayed
 - Metal objects have been dropped inside the product
- When existing wires are used, it is possible that they contain AC voltage. Contact an authorized service center.



CAUTION

Preventing accidents, injuries, and property damage

- Do not use the product in unstable areas or areas prone to strong vibrations. This may cause the product to fall, resulting in damage to the product or injury.
- If the wiring passes outdoors, use a conduit and a surge protector.
- If the wiring passes underground, use a conduit, and do not make any connections underground.
- Install the product securely with screws according to the instructions in this document to prevent it from falling off the wall. Avoid installing onto low-strength walls, such as gypsum board, ALC (autoclaved lightweight concrete), concrete block, or veneer (less than 18 mm thick) walls.
- The DC adaptor is used as the main disconnect device. Ensure that the power outlet is installed near the product and is easily accessible. Ensure that the power supply of PoE hub is connected to a breaker in an easily accessible distribution board. *1
- Do not put your ear(s) near the speaker, as loud sounds emitted from the speaker may cause hearing impairment.
- To prevent serious injuries due to the product unexpectedly falling, the product with a wall mount feature must be installed at a height of 2 m or lower.

*1 Room monitor only

*2 Door station only

Important safety instructions

When using this product, basic safety precautions should always be followed to reduce the risk of fire, electric shock, or personal injury. *1

Follow the power supply instructions indicated in this document.

1. Do not use this product near water. For example, near a bathtub, wash bowl, kitchen sink, or laundry tub, in a wet basement, or near a swimming pool, and the like.
2. Use only the ethernet (LAN) cable or DC adaptor indicated in this document.

*1: Room monitor only

SAVE THESE INSTRUCTIONS

Privacy and rights of portrait

When installing or using the product, please take into consideration the rights of others with regard to privacy and rights of portrait.

- It is generally said that "privacy" means the ability of an individual or group to stop information about themselves from becoming known to people other than those whom they choose to give the information. "Rights of portrait" means the right to be safe from having your own image taken and used indiscriminately without consent.
- Please observe the legal regulations (data protection, video surveillance) in your country during use.

Data security

In order to use the system safely and correctly, the data security guidelines (listed below) must be observed. Failure to do so may result in the following.

- Loss, leakage, falsification or theft of user information.
- Unauthorized or illegal use of the system by a third party.
- Interference or suspension of service caused by a third party.

What is user information?

User information is defined as the following types of information.

- Information stored in the product
 - System event information
 - If no Micro SD card is inserted, voice messages and pictures will be recorded to the product's internal memory. *1
 - If a Micro SD card is inserted, voice messages, pictures, and videos will be recorded to the Micro SD card. *1
 - Resident names and room numbers*1
 - Messages
 - System and device settings
- Information stored on the computer that is used by the setup tool (CMS)
 - Resident names and room numbers
 - System and device settings

Data security guidelines

- **Observe proper management of passwords.**

- Passwords can be used to program the system, open doors, etc. Select passwords that are difficult to guess, change them regularly, and keep them secret. Assign a unique password to each device.
- You will never receive inquiries about passwords from Panasonic.

- **Use caution when entering or saving contact information for use by the system. *1**

- When configuring email addresses, room numbers, or other contact information, make sure all information is entered correctly. Incorrect information could cause user information to be disclosed to unintended recipients.

- **Protect user information when sending the product to be repaired, or when handing it over to a third party.**

- Use the product's reset function to initialize the product before when sending the product to be repaired or handing it over to a third party.
- Note that user information may be deleted or initialized when the product is repaired.
- Refer all repairs to a trusted Panasonic service center.

- **Protect user information stored on the computer used to configure the system.**

- When user information is stored on a computer, the confidentiality of that information becomes the responsibility of the installer. Take precautions to prevent the unauthorized use of the computer and the setup tool (SCS and CMS) used for performing system configuration or maintenance.
- Connect the computer to the network only when performing system configuration or maintenance, and disconnect the computer from the network as soon as the work is complete.
- Use a secure network that is protected by a firewall, etc.
- To prevent the leaking of personal information, enable a screensaver for the computer that uses a password.
- Before disposing of the computer, ensure that data cannot be retrieved from it by formatting the hard disk and/or rendering it physically unusable.

- **Protect user information when disposing of the product.**

- Use the product's reset function to initialize the product before disposing of the product.
- Remove and erase the Micro SD card. *1

*1: Room monitor only

Disclaimer

- Recorded data may be altered or deleted as a result of incorrect operations, exposure to static electricity, accidents, malfunction, repairs or other operations.

To the maximum extent permitted by applicable law, Panasonic assumes no liability for any direct or indirect damages resulting from the loss or alteration of recorded data.

- To the maximum extent permitted by applicable law, Panasonic assumes no responsibility for injuries or property damage resulting from failures arising out of improper installation or operation inconsistent with this document.

- To the maximum extent permitted by applicable law, Panasonic will not be held responsible for any damage or loss due to non-performance or delay in performance, error or failure of network and/or any products.

For best performance (Room monitor)

Environment

- The product should not be exposed to direct sunlight.
- The product should be kept away from heat sources such as heaters, kitchen stoves, etc. It should not be placed in rooms where the temperature is less than -10 °C or greater than 55 °C. Damp basements should also be avoided.
- Do not install the product in locations that are suspect to sudden changes in temperature. Failure to do so may cause condensation to form on the product causing malfunction.
- In areas surrounded by a high electrical field, disturbances may occur in the product's image or sound.

Other important information

- Before attempting to connect or operate this product, please read the nameplate on the bottom or rear of the product.
- When you leave the product unused for a long period of time, consult the installer regarding unplugging the product from the power outlet.*1
- If you stop using this product, remove it from the walls to prevent it from falling off.
- When power fails, this product cannot be used.
- Panasonic may not be liable for damages due to external factors such as power failures.
- The recorded images may be lost when: *1
 - Mishandled
 - Electric shock or radio wave interference occurs.
 - The power is turned off during use.
- Do not unplug the Micro SD card when recording, this generally will cause loss of data. *1

*1: Room monitor only

General information

- In the event of problems, you should contact your equipment supplier in the first instance.
- After removing the product and any included items from the packaging, store, dispose, or recycle the packaging as necessary. Note that certain types of packaging may be a suffocation or choking hazard.

Cleaning

Wipe the product with a soft, dry cloth.

- For excessive dirt, wipe the product with a cloth slightly dampened with fresh water.
- When the product is installed near ocean coasts, wipe the product with a cloth slightly dampened with fresh water once every 2 to 3 months.*1

Important:

- **DO NOT USE ANY SOLVENTS CONTAINING CHLORINE. This causes the product to rust.*1**
- **Do not use any cleaning products that contain alcohol, polish powder, powder soap, benzine, thinner, wax, petroleum, or boiling water. Also do not spray the product with insecticide, glass**

cleaner, hair spray or wall paint. This may cause a change in color or quality of the product.

When cleaning the room monitor display

Use a soft, dry cloth to clean the display, making sure not to scratch its surface.

- Before cleaning the display, we recommend you use the “Clean mode” (6.10 Main Setting page) to disable the display temporarily.

*1: Door station only

Open source software notice

Parts of this product use open source software supplied based on the relevant conditions of the Free Software Foundation’s GPL and/or LGPL and other conditions. Please read all license information and copyright notices related to the open source software used by this product.





This information is available at the following web page:

<https://security.in.panasonic.com/products/vl-vqs300sx>

At least three (3) years from delivery of this product, Panasonic Corporation will give to any third party who contacts us at the contact information provided below, for a charge of no more than the cost of physically distributing source code, a complete machine-readable copy of the corresponding source code and the copyright notices covered under the GPL and the LGPL. Please note that software licensed under the GPL and the LGPL is not under warranty.

<https://security.in.panasonic.com/products/vl-vqs300sx>

Graphical symbols for use on equipment and their descriptions

Symbol	Explanation
	Alternating current (A.C.)
	Direct current (D.C.)
	Caution: risk caused by visible radiation
	For indoor use only
	Class II equipment (equipment in which protection against electric shock relies on Double Insulation or Reinforced Insulation)

Terms and illustrations

- Design and specifications are subject to change without notice.
- Illustrations may vary slightly from the actual product.

Trademarks (Room monitor)

- iPhone is a trademark of Apple Inc., registered in the U.S. and other countries and regions.
- App Store is a service mark of Apple Inc.
- Android and Google Play store are trademarks of Google LLC.
- QR Code is a registered trademark of DENSO WAVE INCORPORATED in Japan and other countries.
- All other trademarks identified herein are the property of their respective owners.

1. Technical Specifications

Door Station

- High quality aluminum alloy housing: IP65, IK07
- Color HD CMOS camera: 1920 x 1080
- Viewing angle: H120° V62° D145°
- White LED for night vision
- Speaker volume adjustable
- Door lock release
- 4 Wires in polarity
- Surface mounted, corner bracket available
- Operation temperature: -10 °C to +55 °C
- Dimensions(mm): Approx. 133(H) x 48(W) x 21(D)
- Mass (Weight): Approx. 190 g

Room Monitor

- 7 inches capacitive touch screen monitor, 1024 x 600 resolution
- Built-in Wifi control by iPhone and Android™ phone
- Support 2 channel 4 wire video door bell
- Inner flash support auto and manual picture recording
- Support alarm triggering send notification to mobile phone
- Support 8 zone alarm in and 1 alarm out
- Support up to 5 sub-monitors
- Support intercom between main and sub-monitor
- Operation power: 48 V standard PoE / 12 V DC
- Operation temperature of room monitor: -10 °C to +55 °C
- Operation temperature of DC adaptor: 0 °C to 40 °C
- Operating system: Linux
- Inner flash record:
 - for auto record: Max 100 pcs pictures
 - for manual record: Max 100 pcs pictures
- Support Micro SD card (8 GB to 32 GB)
- Dimensions (mm): Approx. 180(W) x 125(H) x 19(D), excluding protruding sections
- Mass (Weight): Approx. 380 g
- Wireless network:
 - Wifi IEEE802.11 b/g/n, 2.4 GHz, Transmission power: b/g/n---54.1/29.6/18.5 mW (Max)

2. Packing Contents

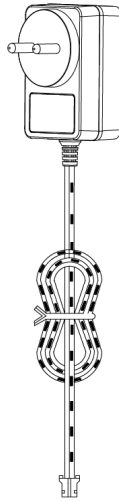

DC Adaptor

Door Station



Main body

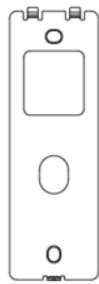

Flat installation wall bracket

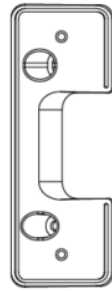

Angle installation wall bracket



Hex wrench



Plastic expansion pipe
(4 mm x 35 mm)



Screw
(4 mm x 35 mm)



Screw
(4 mm x 8 mm)



Hex screw
(3 mm x 6 mm)

Room Monitor

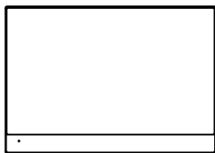

Main body

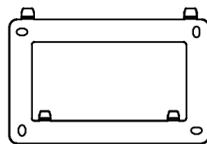

Wall bracket



Screw (4 mm x 35 mm)

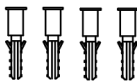

Plastic expansion pipe
(4 mm x 35 mm)

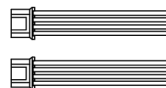

4 pin wiring cable





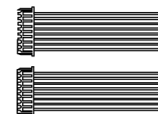







2 pin wiring cable



8 pin wiring cable

Plastic packaging materials information for this product

Plastic packaging material	Recycling mark	Thickness	Importer EPR number
Top cushion		50 Microns or more	Panasonic Life Solutions India Pvt. Ltd. EPR number : 2023030608544812298
Bottom cushion		50 Microns or more	
Bag for Door station main body		50 Microns or more	
Protective film for Door station main body		50 Microns or more	
Bag for Screw / Expansion pipe		50 Microns or more	
Bag for Screw / Wrench		50 Microns or more	
Bag for Room monitor main body		50 Microns or more	
Protective film for Room monitor main body		50 Microns or more	
Bag for Screw / Expansion pipe		50 Microns or more	
Bag for Cable		50 Microns or more	

This information is prepared in accordance with India / Plastic Waste Management (Amendment) Rules.

3. Name and Functions of Each Part

Door Station

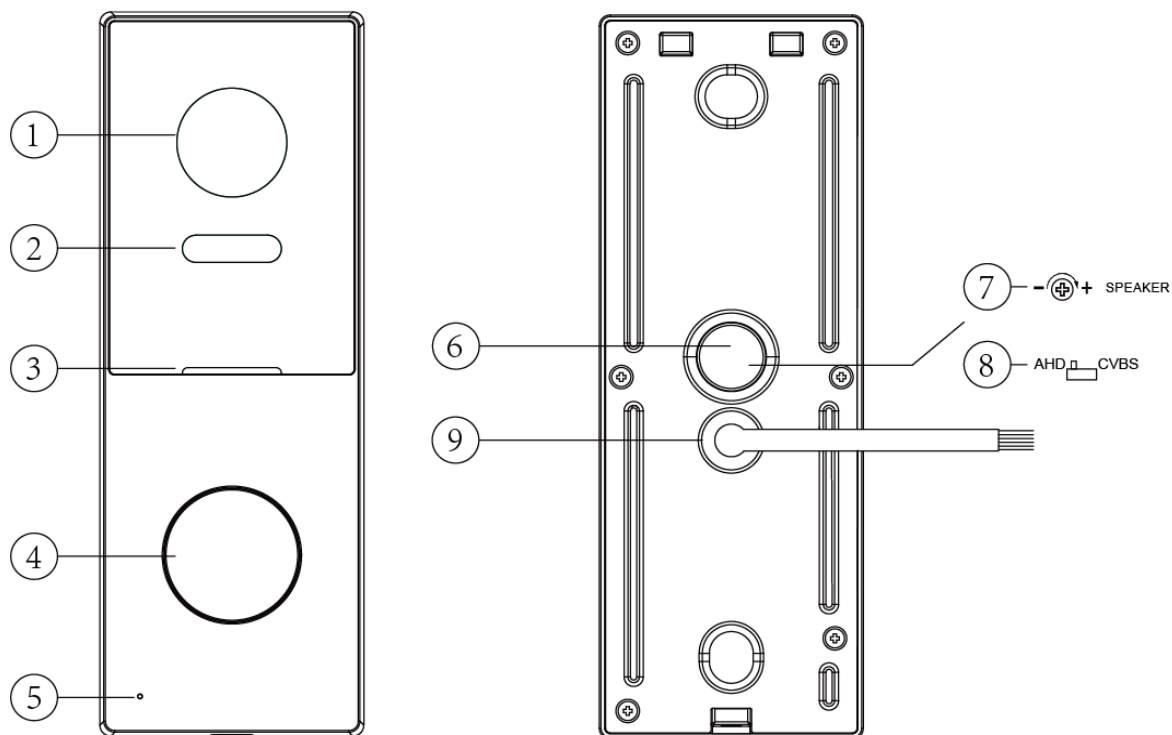

NO.	Part Name	NO.	Part Name
1	Camera	6	Cover for the switches
2	LED for night vision	7	SPEAKER volume adjust ^{*1}
3	Speaker	8	AHD/CVBS switch ^{*2}
4	Call button	9	Wires for monitor/electric lock
5	Microphone		

*1 There's a rubber on the door station backside, you can check the knob inside. If you need to increase the volume came from the other side during an intercom call, turn the volume adjustment knob clockwise to make the sound louder. Conversely, turning it counterclockwise will decrease the sound.

*2 Normally the Door Station has two standards: CVBS and AHD (1080P), to ensure that Door Station and Room Monitor could establish regular image, Room Monitor needs to set corresponding standard in the "Engineering Setting">"Set Video Door Bell Resolution":

There's a rubber on the Door Station backside, you can check the switch inside (left is AHD, right is CVBS), which can switch different standards. If you choose CVBS, the Room Monitor side needs to choose CVBS. If you choose AHD, Room Monitor side needs to choose 1080P. Also, the default setting will be AHD on Door Station side, 1080P on Room Monitor side.

Room Monitor

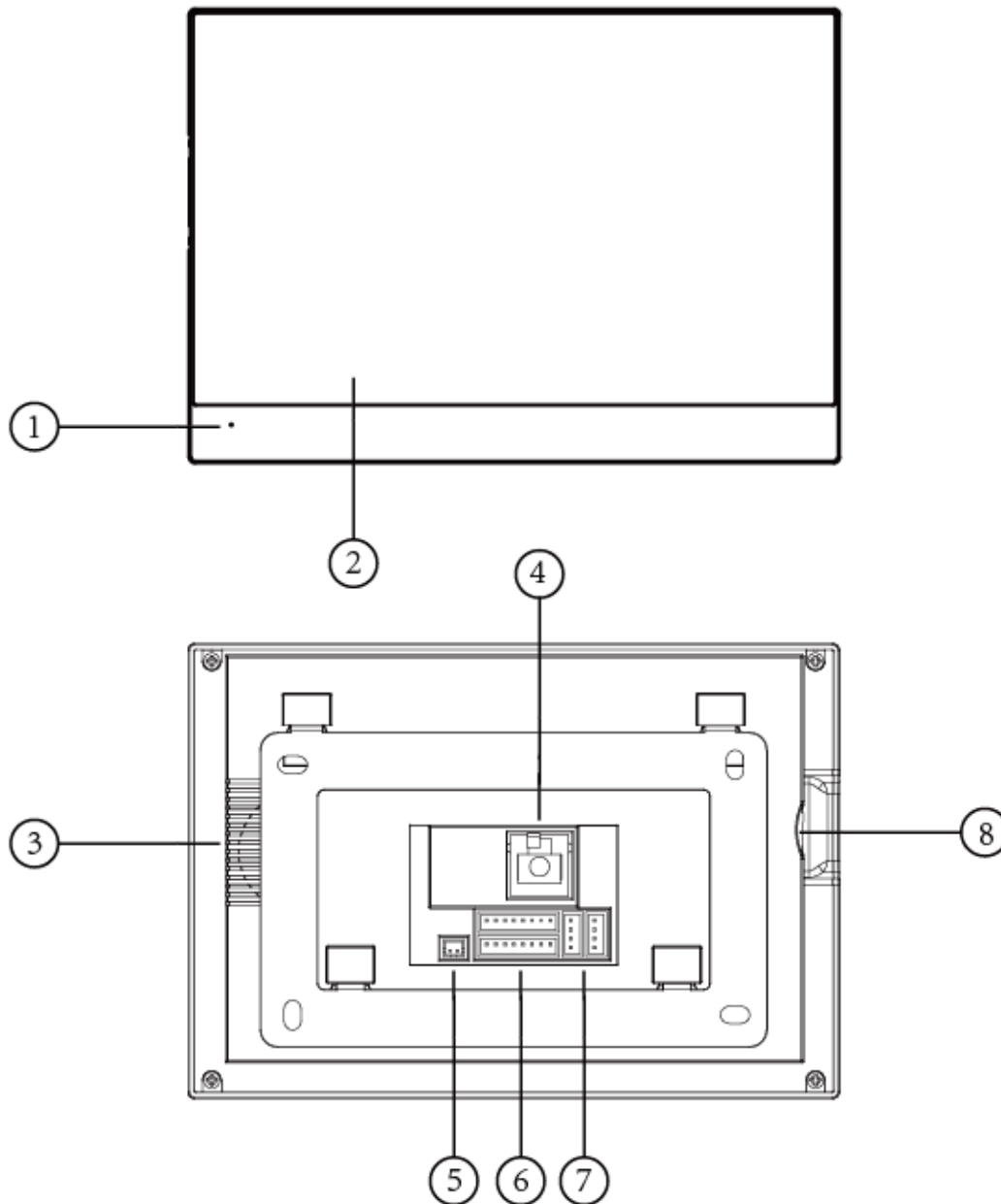

NO.	Part Name	Description
1	Microphone	Receive voice from the user
2	Screen	7 inches digital TFT LCD
3	Speaker	Send voice to user
4	RJ45 Connector	Interface for PoE switch or network switch
5	DC Power	12 V DC power supply
6	Connection Port	Interface for alarm sensor
7	Video Input	Interface for video door bell
8	Micro SD Card Slot	Socket for Micro SD card

4. Connection Diagram

4.1 System Layout

- The distance between device (indoor monitor, network switch, and PoE Switch) and PoE Switch is limited to 70 meters.
- The distance between nodes is limited to 70 meters. (Node: PoE Switch or network switch. You can add node to extend the distance.)
- The system supports villa mode and apartment mode.
- For the Video Intercom Kit, select the Villa mode.
- Villa mode supports 2 door stations and 6 monitors in one family.
- The system supports two Network configurations (Auto and Manual).
- In the case of the Video Intercom Kit (1 door station and 1 room monitor), the following features on the monitor screen are not used.
 - Apartment mode
 - SIP
 - Building panel ring tone/Guard unit ring tone
 - Building panel in Monitor Function

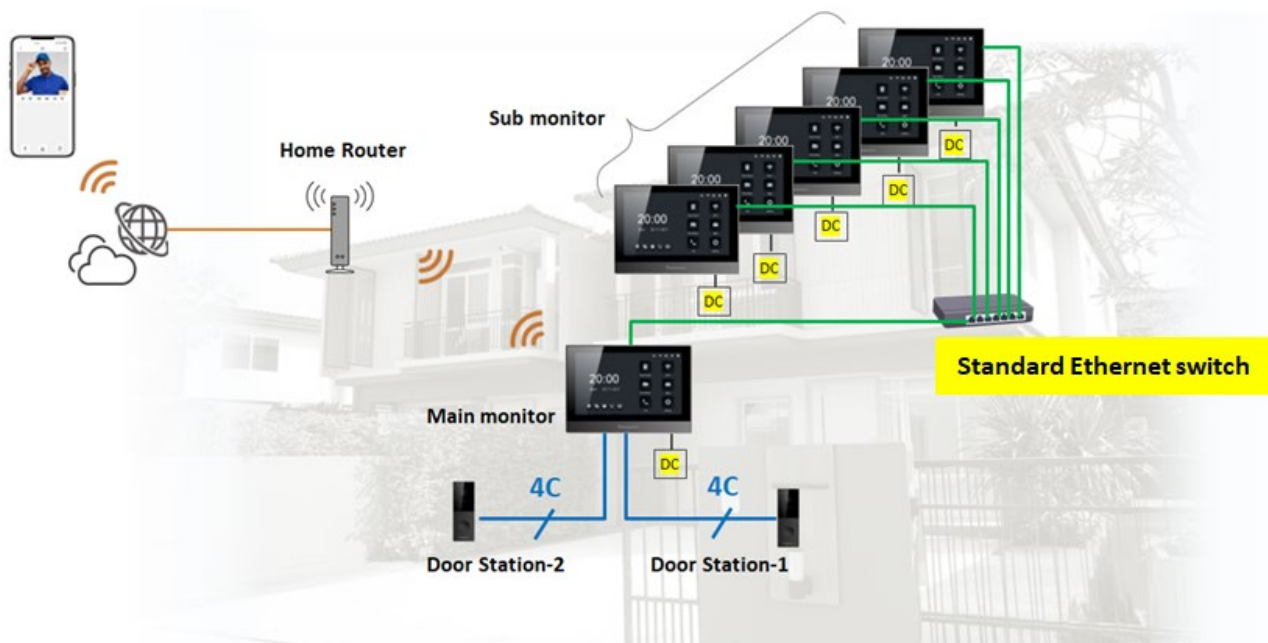

If PoE is available on your network, this product can receive the necessary power from the network through the Ethernet cable and no DC adaptor is needed.

4.2 Wiring Diagram

Door Station

Please be careful to wiring on polarity.

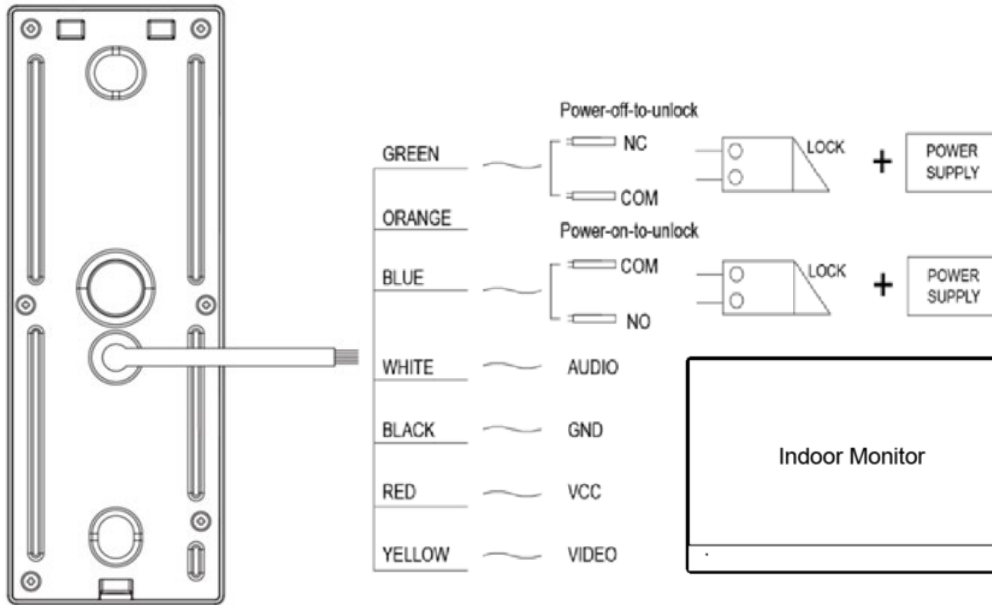

Note:

1. The external power supply must be used according to the lock.
2. The inside relay contact is restricted to DC 3 A/30 V.
3. There are two unlock types as the follows:

Type 1: Power-on-to-unlock

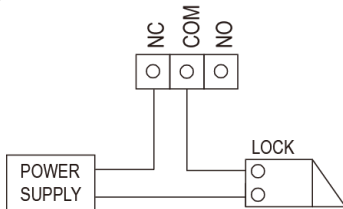

Type 2: Power-off-to-unlock

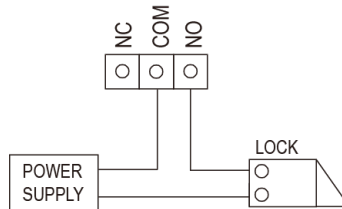

Room Monitor

Picture below is the interface of the monitor. ALM1, ALM2, ALM3, ALM4, ALM5, ALM6, ALM7, ALM8 are interfaces that respectively connect alarm sensors of different zones.

Remark:

- The 12 V out is used for the alarm sensor which needs additional power. And the maximum current is 150 mA.
- The monitor supports 2 video doorbell input.
- It also supports 1 alarm out.

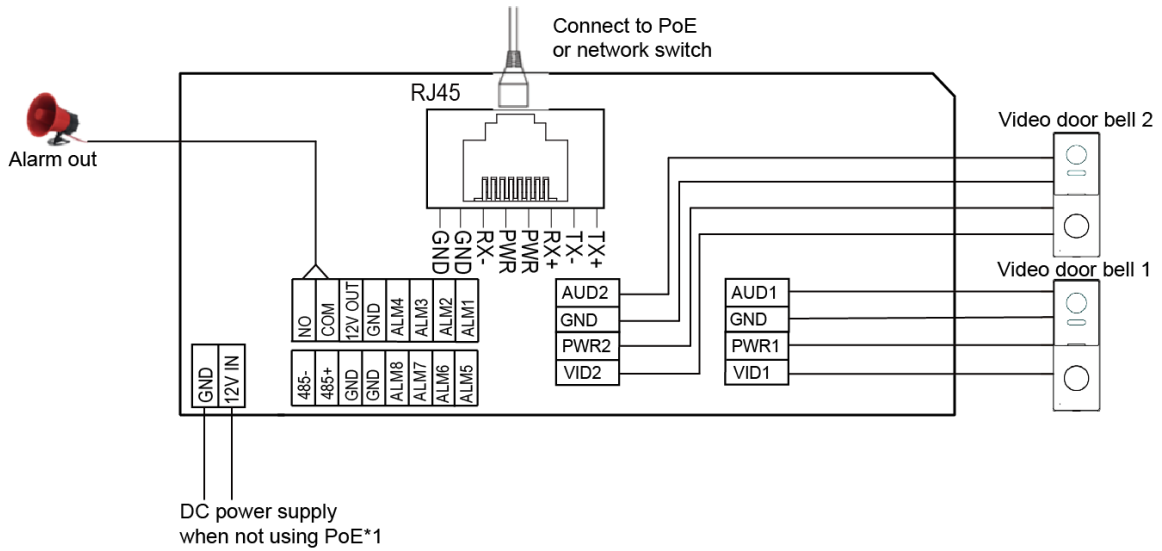

*1 If PoE is not available, connect the DC adaptor to the product as follows:

- 1) Strip the remaining ends of the DC wires.
- 2) Solder the ends of the wires from the DC connector and the DC adaptor.
(Connect ensuring that the polarity of DC+ and DC- is correct.)
- 3) Use insulation sleeves to insulate the wires.

5. Installation

Door Station

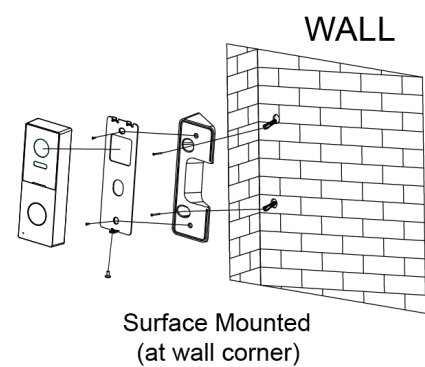
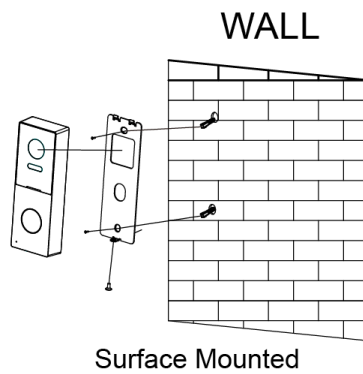
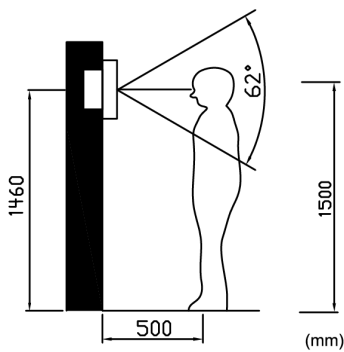

Camera installation location

Standard installation height of outdoor station: lens's height is about 1,500 mm above the floor; in this case, installation wall bracket center is about 1,460 mm above ground level.

Room Monitor

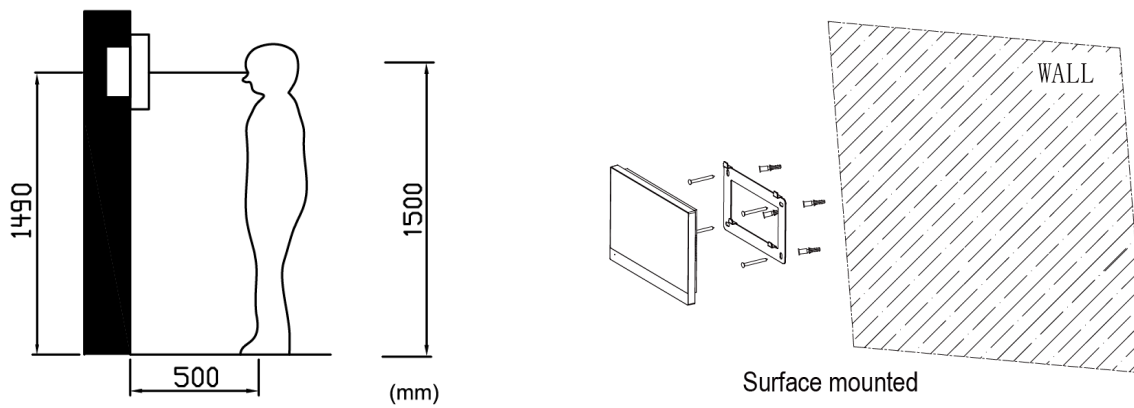

Monitor installation location

Standard monitor installation height is about 1,500 mm where screen center is at eye level; in this case, wall-hanging metal center is 1,490 mm above ground level.

Wiring and installation of indoor monitor

- 1) Remove mounting bracket behind monitor and fix it on the wall with screw;
- 2) Pull the cable out and connect the system according to wiring description;
- 3) Hang the monitor on the mounting bracket.

6. Operation Description





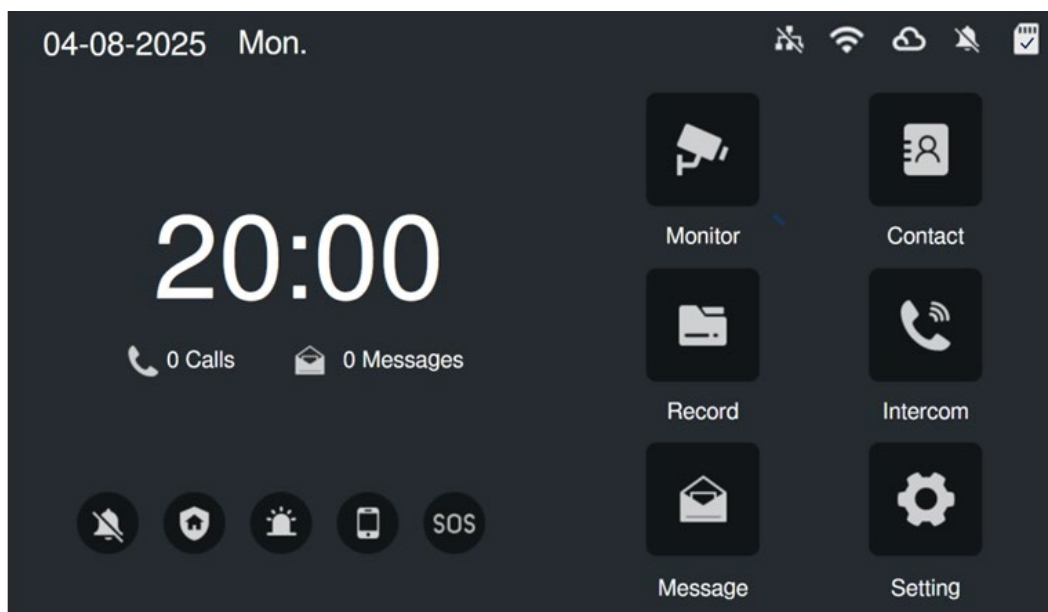









6.1 Main Screen

Touch the screen anywhere in standby mode, the main page will be shown as follows:



It will show corresponding functions when pressing each icon on main screen.

※ Icon Definition



	Enter the monitor menu		Contact lists
	Media record		Enter the call menu
	Enter the message menu		Enter the setting menu
	Do Not Disturb		Alarm management
	Alarm mode switching		Call App
	SOS		Not connected to system
	Wifi connection		Server connection
 *1	Micro SD card inserted		

*1 If  is displayed, it means the Micro SD card is not inserted.

If  is displayed, it indicates a formatting error with the Micro SD card.

Remark:

If the Wifi indicator becomes to , it indicates that the device has not successfully connected to the server. If it keeps showing connect server failed after few minutes, please check if the Internet network is OK.

If the Wifi indicator becomes to  and the server connection  is shown, that means the monitor is connected to the server through Wifi successfully.

6.2 Intercom Function

Press the  icon on main screen, the screen will enter the intercom page. You can call other monitor, review call record, set general call setting and SOS function.

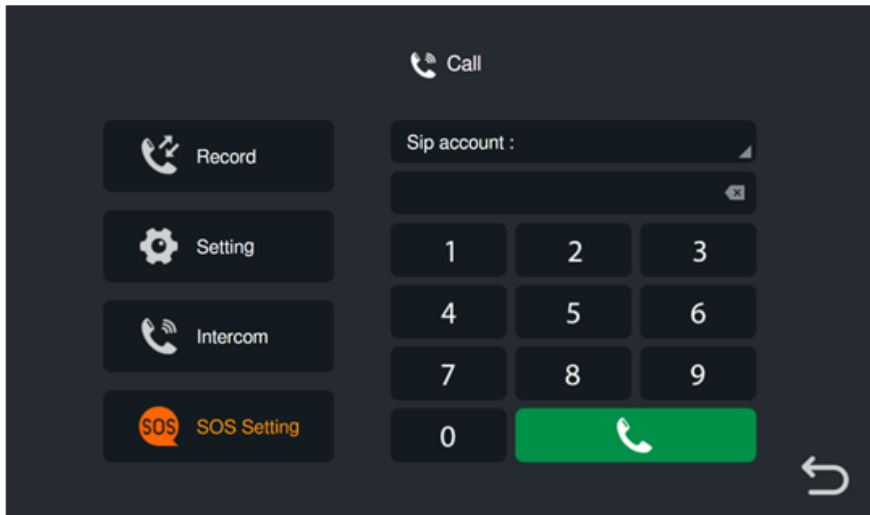

6.2.1 Record

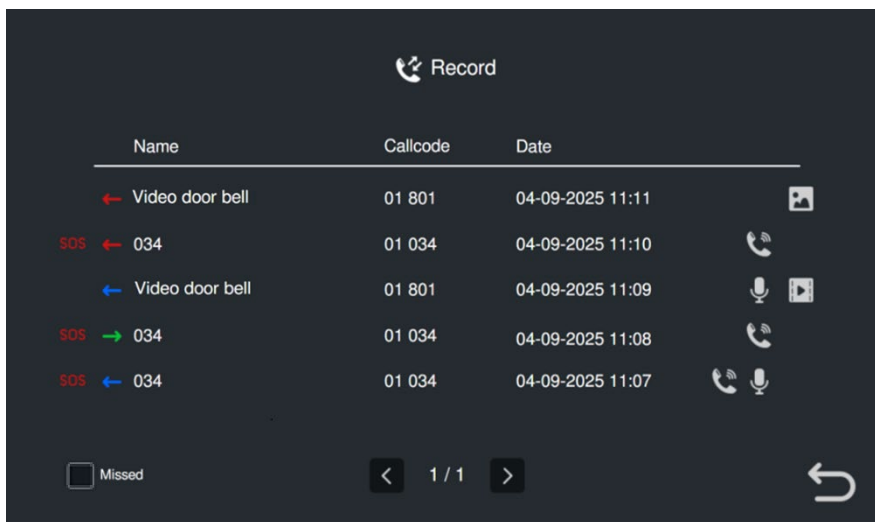

In [Record], you can

- Press to review the voice message from visitor when leave message function is enabled.
- Press to review the picture automatically captured when receive external call.
- Press to review the video automatically captured when receive external call.
- Press to call back to other rooms.

Remark:

- Long press a call records for 2 seconds; you can delete the call record or delete all records.
- Pictures and voice messages are linked to call records.

6.2.2 Intercom



The device supports intercom between main monitor and sub-monitor.

In the call page, you can press [Intercom] icon to enter main and sub-intercom page. Then you can call main

or sub-monitors.



Remark:

- You can press  to add a device into the call.
- You can press  to forward the call to other devices.

6.2.3 Setting

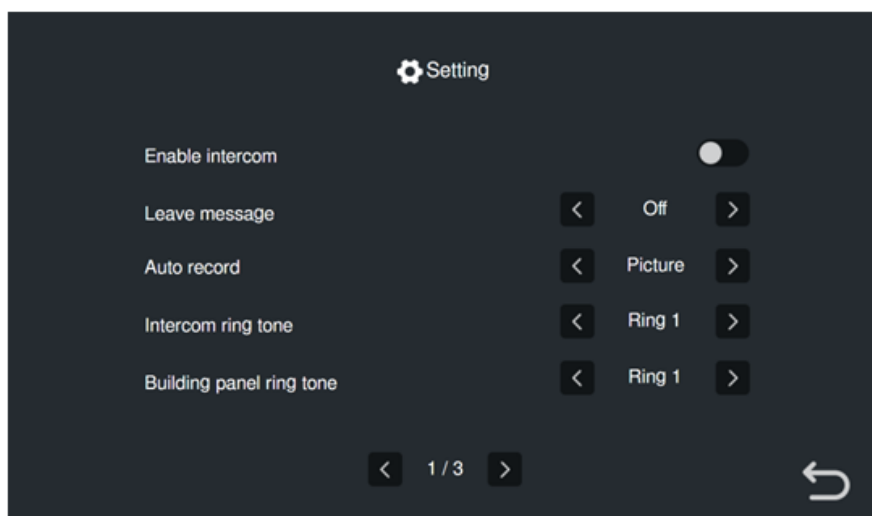

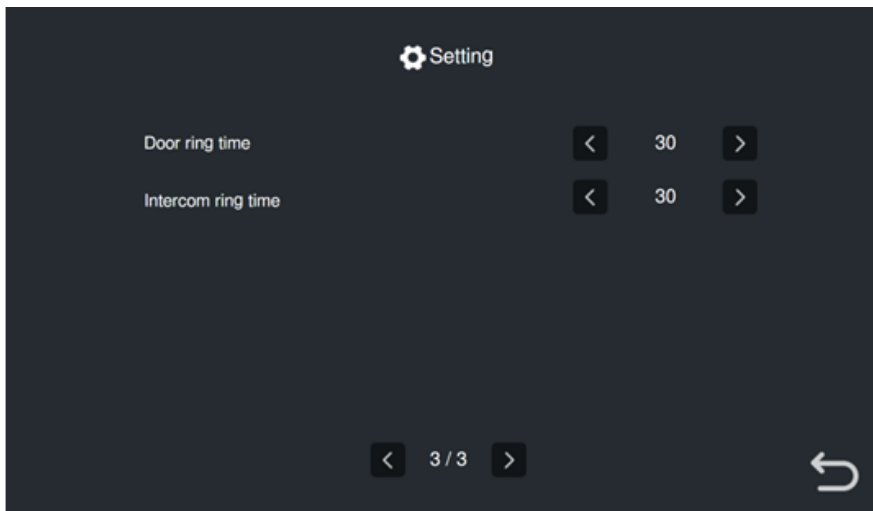
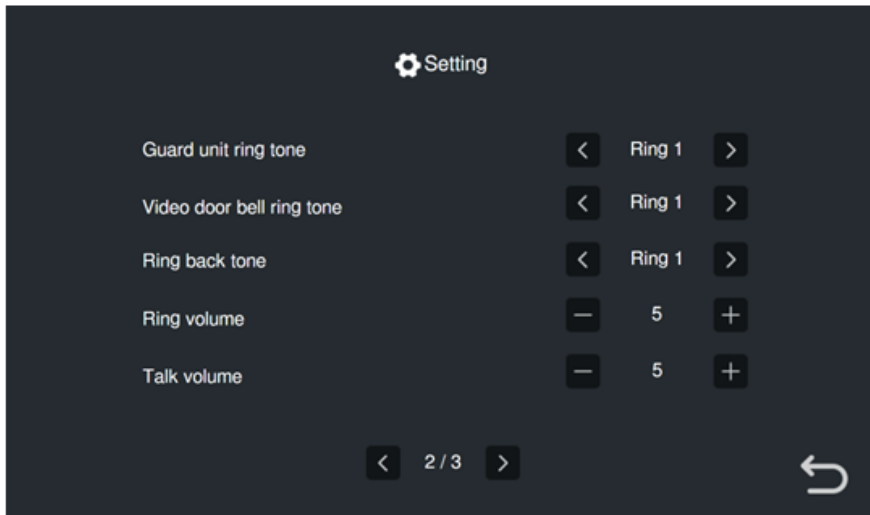

In [Setting], you can

- ◆ Enable/disable the Intercom function; when you disable the intercom function, other monitors are not able to call this monitor.
- ◆ Select the mode of leaving voice message: immediately/timeout/off.
- ◆ Select the mode of auto record: Picture/Video/Off. (The monitor will auto record picture or video when receives calling). Video can be selected after inserting the Micro SD card.
- ◆ Select the melody for Intercom ring tone/Video door bell ring tone/Ring back tone.(Selective 10 melodies)
- ◆ Adjust the talking and ringtone volume.
- ◆ Adjust the door ring and intercom ring time.

6.2.4 SOS Settings

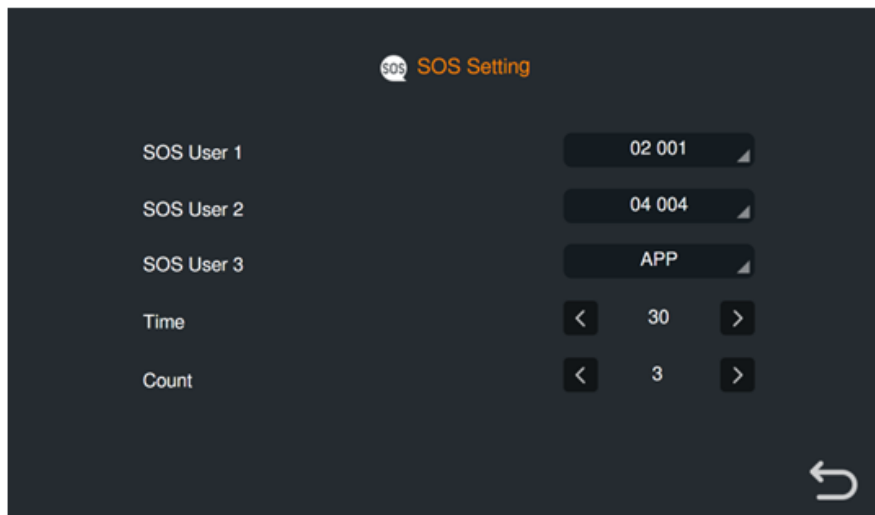







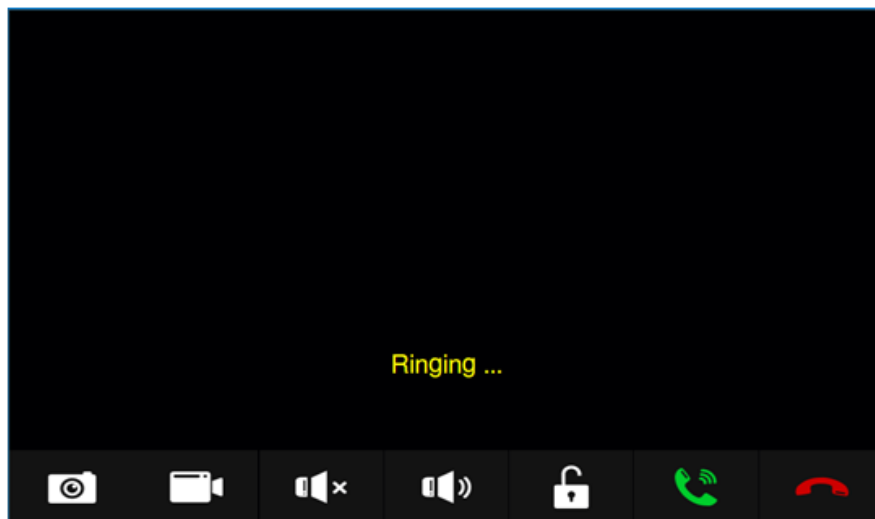

In [SOS Setting], you can

- ◆ Set users for SOS calling. SOS users can be selected from contact book. You can also select APP in Local Contacts.
- ◆ Set the ring time of SOS calling time.(5/10/20/30)
- ◆ Set the ring repetition.(1/2/3)
- ◆ To use SOS function, press the SOS button in the main screen.

6.2.5 Visitor Call from video door bell



- ◆ When door panel calls in, the visitor's image will be shown on the main and sub-monitor screen and you can press the  icon to talk with the visitor.
- ◆ You can press  to capture a photo of visitor.
- ◆ You can press  to record a 15 seconds video of visitor. Micro SD card is required to use this function.

- ◆ Before receiving the call you can press  to modify the ring volume. After receiving the call you can press  to modify the talk volume.
- ◆ You can press  to disable the speaker of the monitor.
- ◆ You can press the  icon and choose which relay to unlock.
- ◆ You can press  to end the call.

6.3 Contact

Press the [Contact] icon on main screen and the screen will enter the contact page, you can review the contacts and click the contact you want to call.

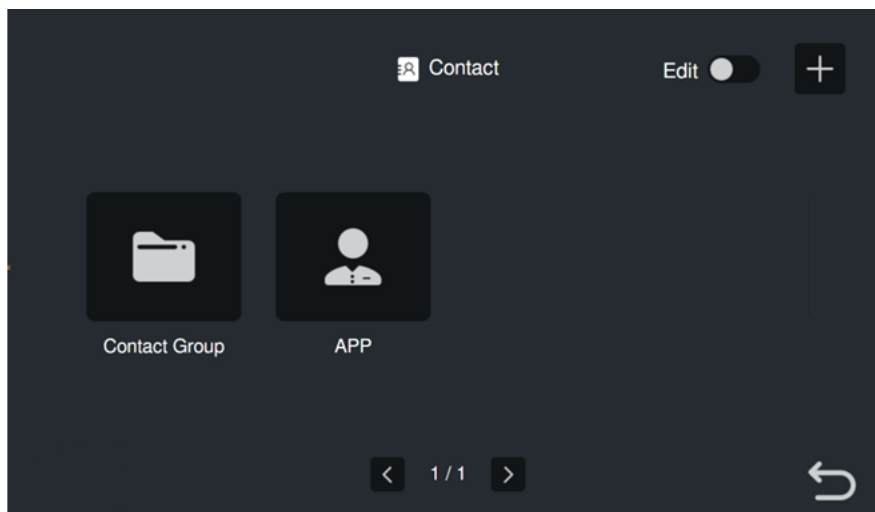



- ◆ You can also press the "+" icon in the upper right corner of the screen to enter the name list page, select the contact you want to add and press the "return" icon to confirm and return to the add contact page. For villa mode you can import the contact list by the web page.

6.4 Message Function

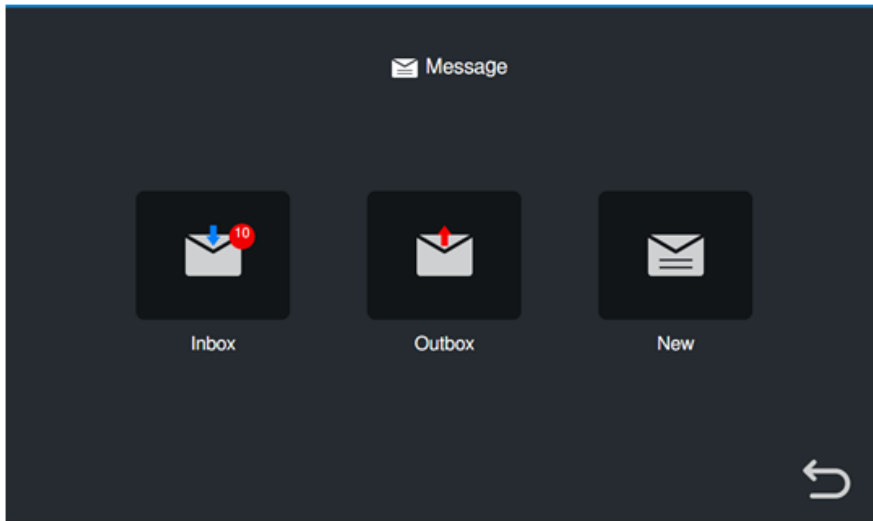
Press the [Message] icon on main screen and the screen will enter the message page:



- ◆ You can press the [Inbox] icon to review the received message; you can also delete, forward and reply messages.
- ◆ You can press the [Outbox] icon to review the messages that have been sent, you can also delete, forward and reply messages.
- ◆ You can press the [New] icon to edit message, input the intercom address of the monitor you want to send or press  to choose from the contact and address book. Then edit the content and press  icon to send the message.

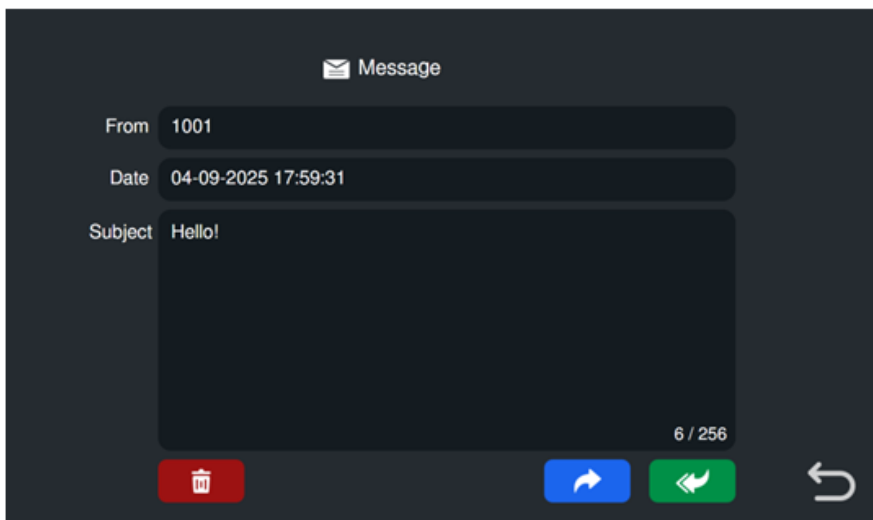

Remark:

- When the monitoring received a new message, there will be a prompt tone.
- Long press the message for 2 seconds, you can delete all messages.

6.5 Monitor Function

Press the [Monitor] icon on main screen, select the door panel/camera or video door bell you want to monitor and then enter the monitoring mode.

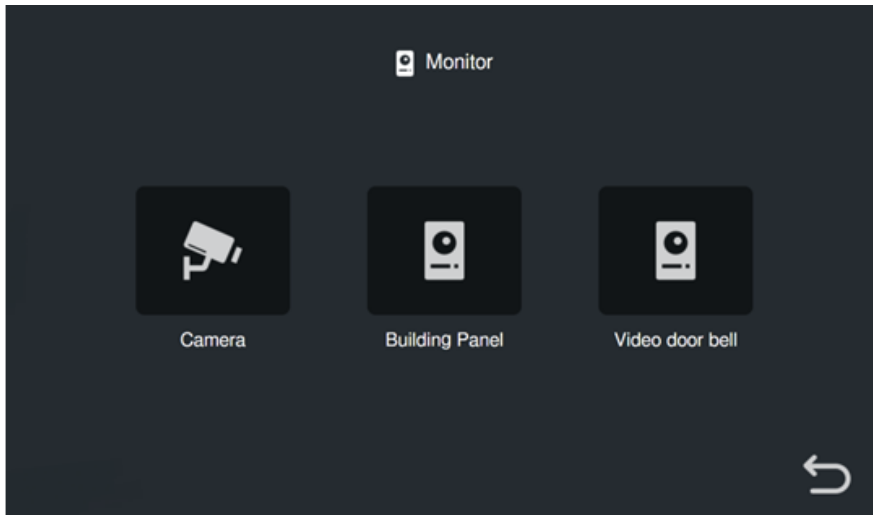

Remark:

- Camera can be added by the monitor.
- When connecting IP cameras, this system supports video streaming only. Audio functions of connected cameras are not available.

6.6 Alarm Function

Press the [Alarm] icon on main screen and enter the password (Default password: 9999), the screen will be shown as follows:

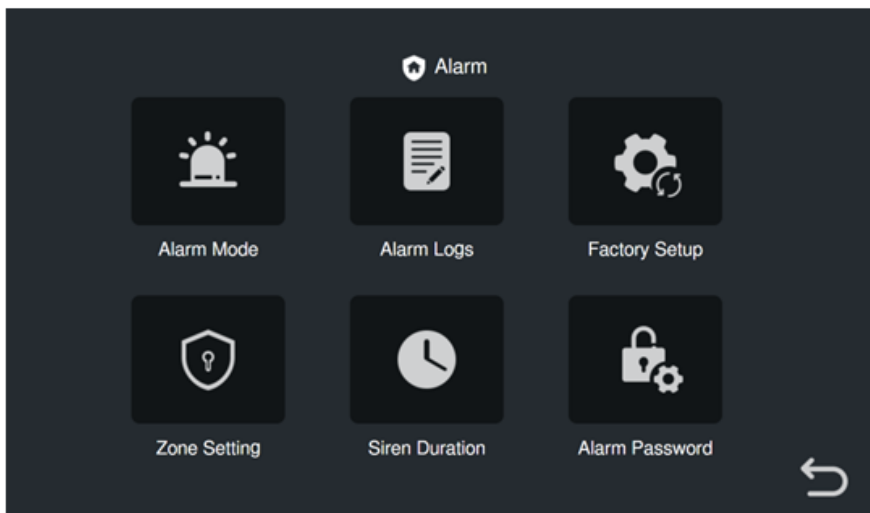

- ◆ In [Alarm Mode] page, you can review and change the status of alarm zones in each mode.
- ◆ In [Alarm Logs] page, you can review the alarm records.
- ◆ In [Factory Setup] page, you can restore alarm setting to factory settings.
- ◆ In [Siren Duration] page, you can set the duration of the siren (1 to 99min).
- ◆ In [Alarm Password] page, you can set the alarm password.
- ◆ In [Zone Setting] page, you can do the followings:

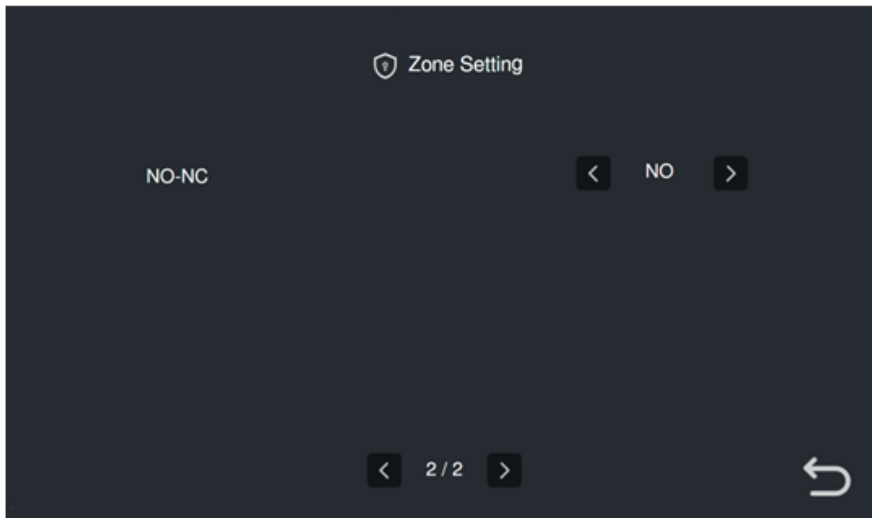
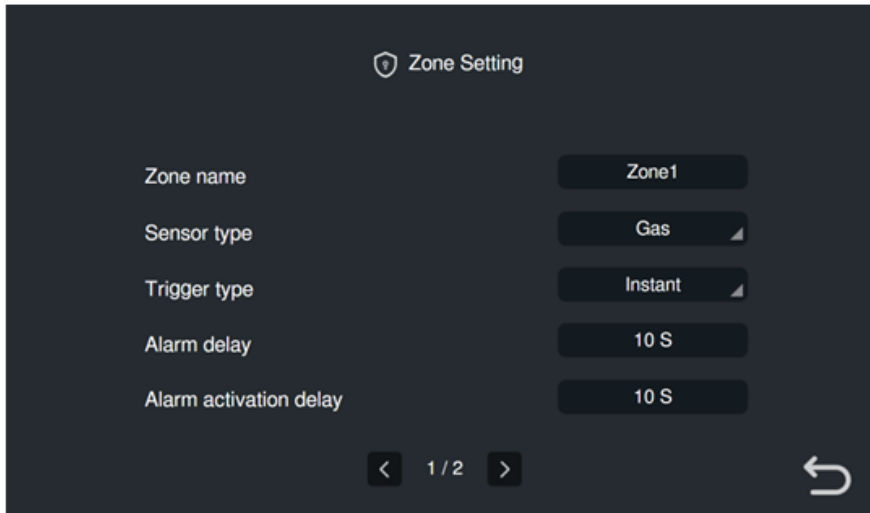

- Set the zone name (default name: Zone1; Zone2; Zone3; Zone4; Zone5; Zone6; Zone7; Zone8);
- Set the type of sensor (Gas/Smoke/Water/Magnetic/Pir/Custom Type);
- Set the trigger type of the sensor (Instant/Delay/24h Instant/ByPass);

Instant: The alarm will be triggered immediately without delay time.

Delay: The alarm will be triggered after reaching alarm delay.

24h Instant: The alarm will be triggered immediately without delay time. This zone will always open in all alarm modes.

Bypass: Disable this alarm zone.

- Set the alarm delay time (1 to 99s);

Alarm delay: Determines the delay time for the alarm to be triggered, within which the alarm can be canceled by entering the alarm password.

- Set the alarm activation delay time (1 to 99s);

Alarm activation delay: Determines how long it takes to start working after the alarm is armed.

- Set the alarm mode (NO/NC);

Remark:

- In the Zone8, you can set the alarm as door bell.
- When the alarm is triggered, the monitor will buzzer at the same time; you can enter the alarm password

and press the  icon to turn off the alarm (default password: 9999).

- You can also change alarm mode in the main menu . When switching the alarm, you will need to enter the alarm password (default password: 9999).

6.7 Motion detect

Press 'Setting—Common—Motion detect' to enter motion detect setting page. You can enable the motion detection, adjust the start and end time and sensitivity. And set the motion detection device from bell 1 or bell 2. After inserting the Micro SD card, motion detection can capture videos. Otherwise, it can only capture pictures.

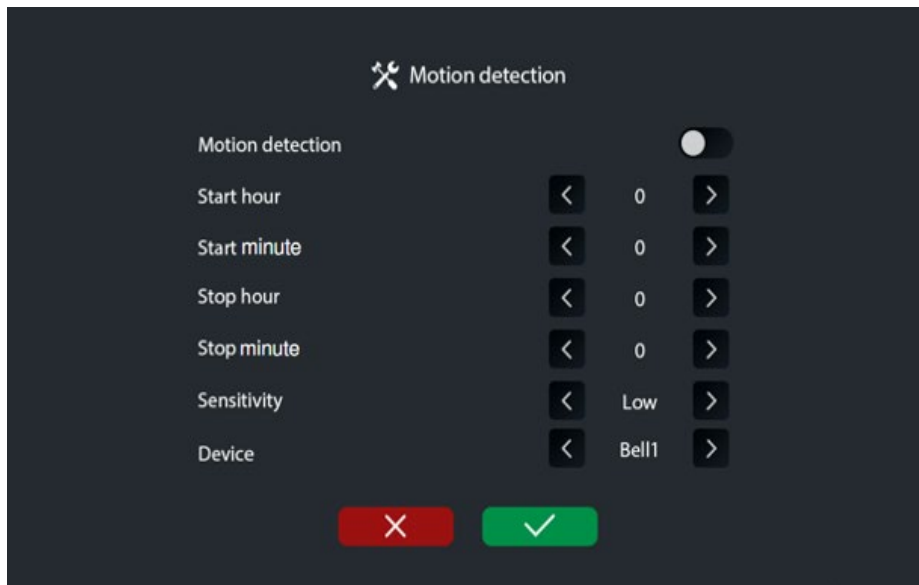

6.8 Record

Press the [Record] icon on main screen, the screen will display as the following:

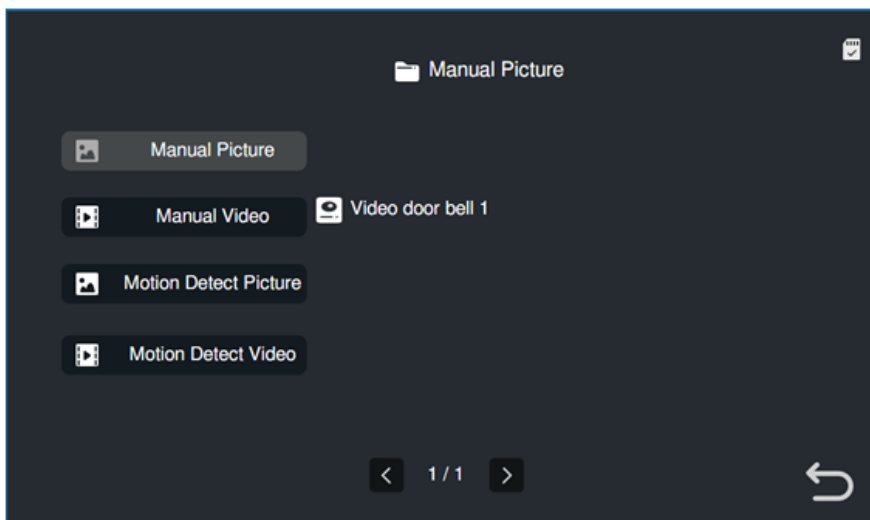

You can select pictures, videos or motion detect pictures or videos to review.

Remark:

- In the record page, you can only review the manually captured pictures and videos and motion detect pictures or videos.
- Long press a picture for 2 seconds, you can delete the picture or delete all pictures.
- The device inner flash record: 100 pcs pictures.
- The device supports 8 GB to 32GB Micro SD card.

6.9 Do not disturb

Press the [DND] icon on main screen, the screen will display as the following:

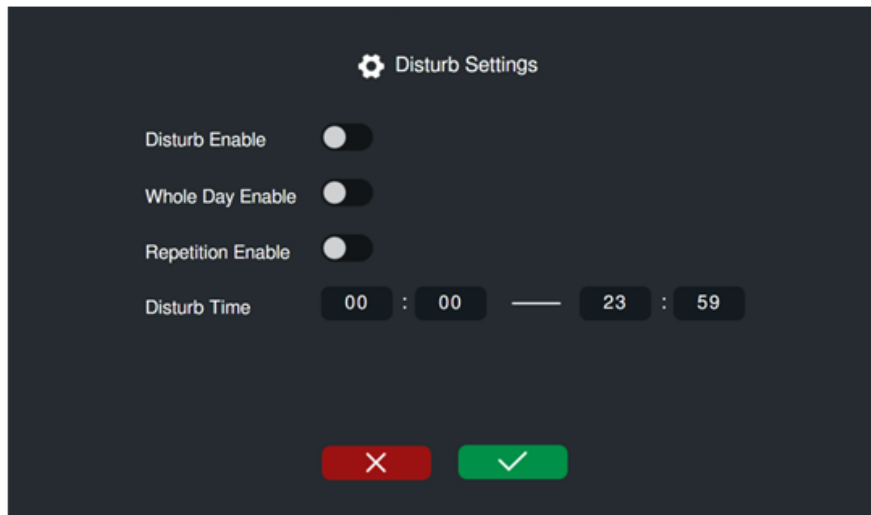

You can enable DND mode and set the auto repetition. And also set the DND time.

Remark:

- You can set enable the DND to work for whole day or set the working time manually.

6.10 Main Setting page

Press the [Setting] icon on main screen and the screen will enter the main setting page.

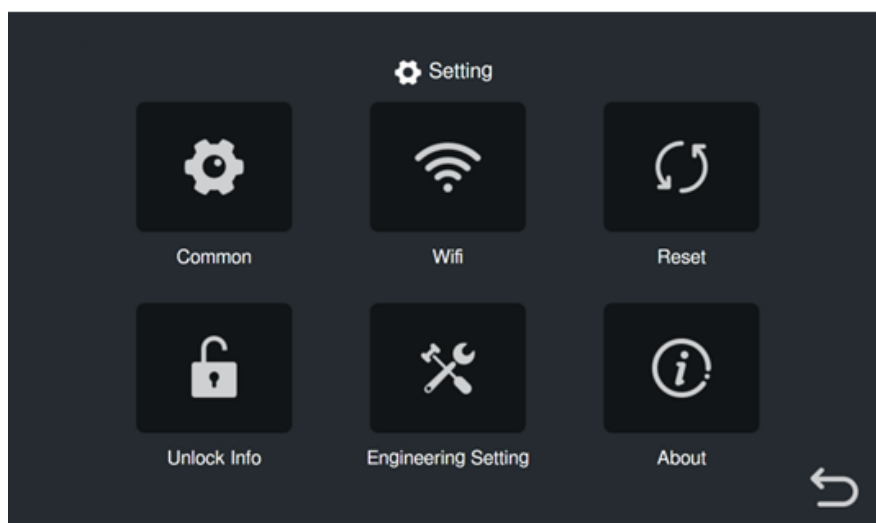

- ◆ In [Common] setting page, you can enable or disable touch tone. Change user name. Open motion detect setting page. Configure the date and time displayed on the device (Under Villa mode). And enable clean mode.

- ◆ In [Wifi] setting page, you can connect the device to Wifi network; you can unbind the device to APP; also can set the call forward to Off/Immediately/Timeout/Group call. And it shows the device UID.
- ◆ In [Reset] setting page, you can format Micro SD card, reset monitor to factory setting (except engineering setting) and restart monitor.
- ◆ In [Unlock Info] setting page, you can set your own unlock password (the password is 4-6 digits; the password cannot be completely consistent or continuous).
- ◆ In [About] setting page, you can review the software version and check IP address of the monitor.

6.11 Engineering Setting

In [Setting], you can press [Engineering Setting] and input the password to enter.

- **Please refer to the included important information leaflet for details about the default password.**

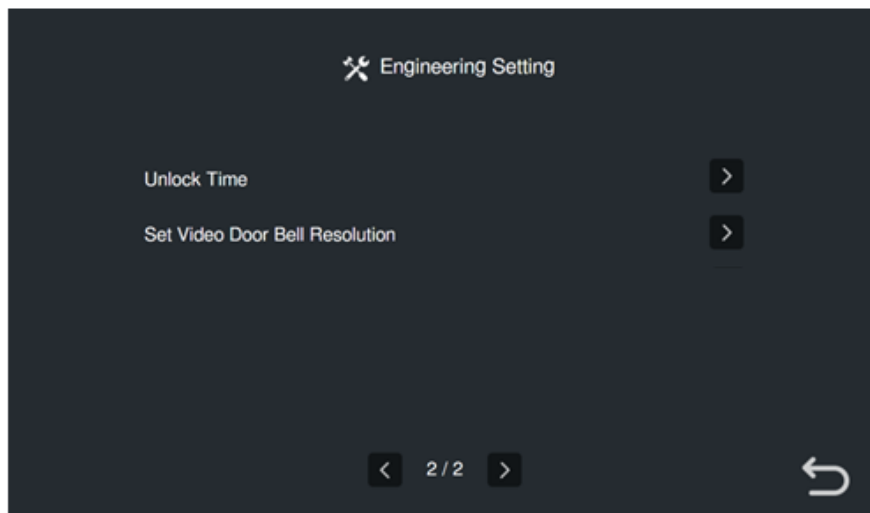
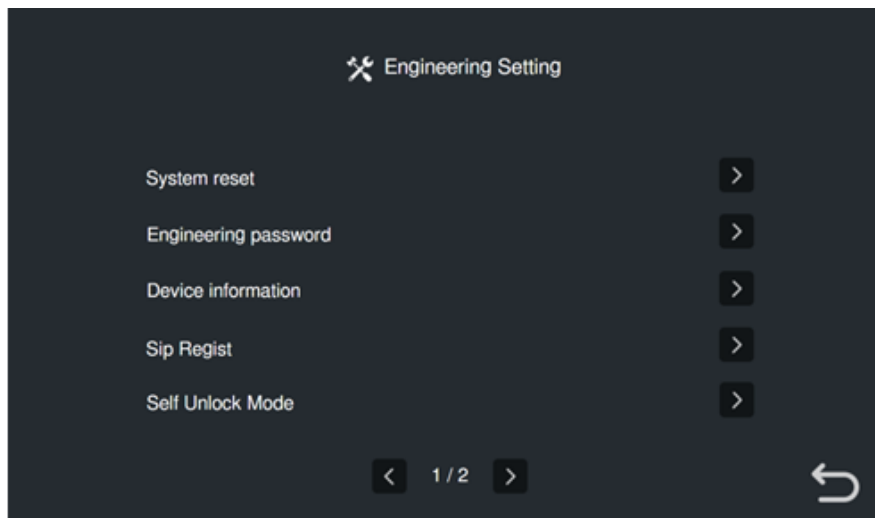

6.11.1 System reset

In [System reset], you can reset the monitor to factory setting (including engineering setting).

6.11.2 Engineering password

In [Engineering password], you can change the password of engineering setting.

6.11.3 Device information

For villa mode

You can set the extension NO. You can also modify the IP address of the monitor and the server.

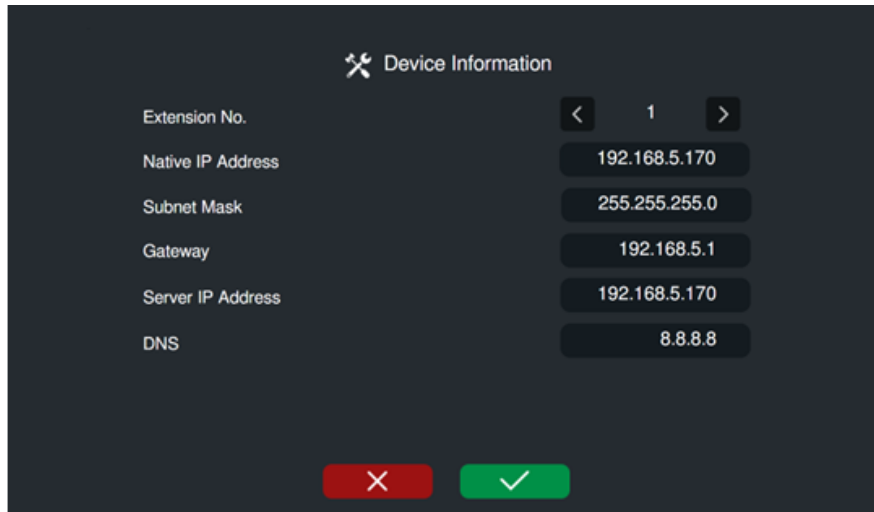

Remark:

One room support 6 indoor monitors (Extension 1: main monitor, Extension 2 to 6: sub-monitors).

The monitor supports auto network configuration and manual network configuration.

To choose villa mode, use system reset to reset the monitor.

6.11.4 SIP register

Press 'Engineering Setting—Sip Regist' to start sip configuration and the screen will enter the following page.

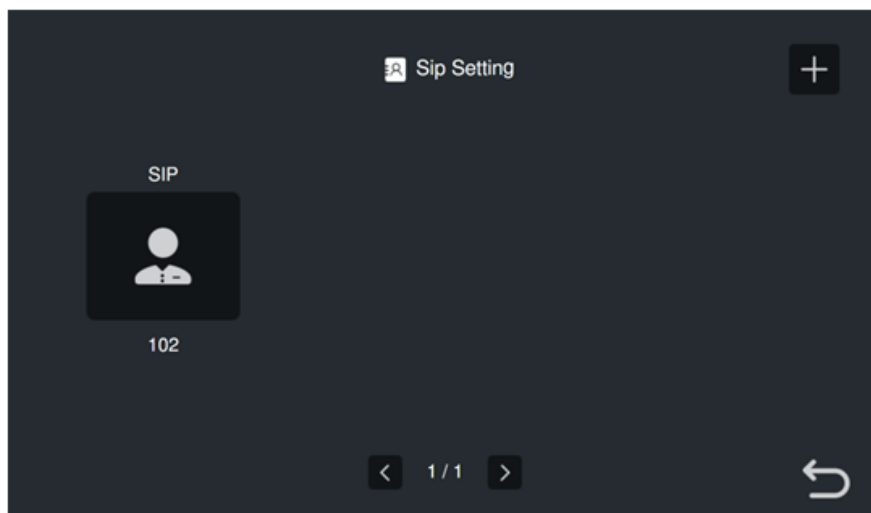

To add SIP server in the monitor, you need to register a SIP account in SIP server in advance. Then press

 to register new SIP server. Enable the SIP server and input the label/name/IP/user name/password. After setting the SIP you can start call in [Intercom] by choosing the SIP server you just registered in SIP account.

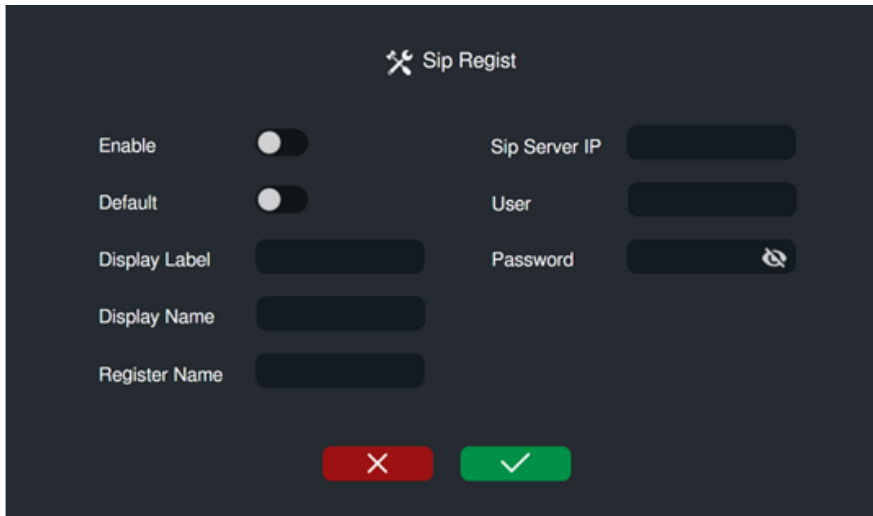

The screenshot shows the 'Sip Regist' configuration interface. It features a title bar with a wrench icon and the text 'Sip Regist'. Below the title, there are two columns of settings. The left column contains: 'Enable' (toggle off), 'Default' (toggle off), 'Display Label' (empty text field), 'Display Name' (empty text field), and 'Register Name' (empty text field). The right column contains: 'Sip Server IP' (empty text field), 'User' (empty text field), and 'Password' (password field with a strength indicator icon). At the bottom, there are two buttons: a red button with a white 'X' and a green button with a white checkmark.

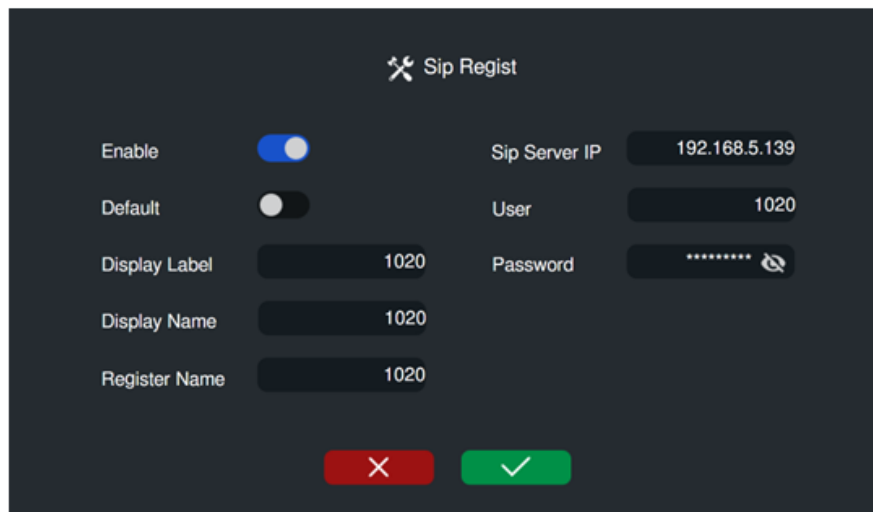

The screenshot shows the 'Sip Regist' configuration interface with the following values: 'Enable' (toggle on), 'Default' (toggle off), 'Sip Server IP' (192.168.5.139), 'User' (1020), 'Display Label' (1020), 'Display Name' (1020), and 'Register Name' (1020). The 'Password' field is filled with dots and has a strength indicator icon. At the bottom, there are two buttons: a red button with a white 'X' and a green button with a white checkmark.

6.11.5 Self Unlock mode

In the alarm Zone 8, you can set the alarm as door bell. You can switch the option to Self Unlock or Alarm Out according to your connection.

6.11.6 Unlock Time

You can configure the unlock time for both two video door bells. Or the self-unlock time if lock is connected to the monitor.

7. Wifi Function

7.1 Add device

1. Enter the main setting page → enter the Wifi setting → connect the device to the Wifi network in “Wifi Config”.
2. Download and Open the application “P-Video Intercom”.
3. Click the “+” icon, and scan the QR code of the device UID (Note: the QR code in the Wifi page).
4. After you scan QR code of the monitor, the APP will query whether the device is online. And if the device is online, you can press [Add] to add the device. Or you have to check whether the device has connected to Wifi network.
5. After you add it successfully, you can set device name and save.

Remark:

- APP download address: iPhone--App Store; Android--Google Play
- The UID of the monitor is unique.
- In order to ensure normal connection, all permissions of the app need to be allowed.

7.2 Control the Monitor through the APP

1. Enter the [Wifi] setting page of the monitor, and choose group call in [Call forward];
2. When door panel calls in, the mobile phone will receive message and show ringing page;
3. Press the accept icon and talk with the visitor;
4. Press the lock icon and then you can release the door lock.

Remark:

- The call forward has off / immediately / timeout / group call options. If you choose off, you will not receive the push. If you choose timeout, you will not receive the push until the monitor ring timeout. If you choose immediately, the device will forward the call to APP at once. If you choose group call, you can receive call on both monitor and APP.

7.3 Unbind the Monitor to the APP

Enter the [Wifi] setting page of the monitor, and press [Remove users]. After confirmation, you can disconnect the monitor from the APP.

8. Web Client Operation

8.1 Login the Client

- >> Connect your computer and device network with a network cable, then modify computer IP address to the same network segment of the system.
- >> Open web browser, input the IP address of the device and press the “Enter” button to enter the login

page;

>> You need to input user name & password, then click “Login” item to enter the local configuration page.

- Please refer to the included important information leaflet for details about the default user name and password.

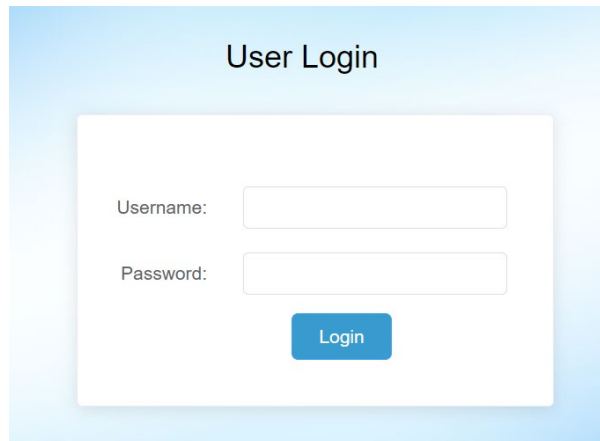

The image shows a 'User Login' form with a light blue background. The form is centered and contains two input fields: 'Username:' and 'Password:'. Below these fields is a blue button labeled 'Login'.

Remark:

The computer and the device need to be on the same network segment, otherwise the login will fail.

8.2 Local Configuration Page

- In the local configuration page, you can review the IP address and device information of device. And you can set the date and time.
- In [Replace Background], you can select a picture file in your computer and replace the background of the device.
- In [Restore Background], you can change the background of the device to default.
- In [Restore Project Password], you can change the engineering password to default.

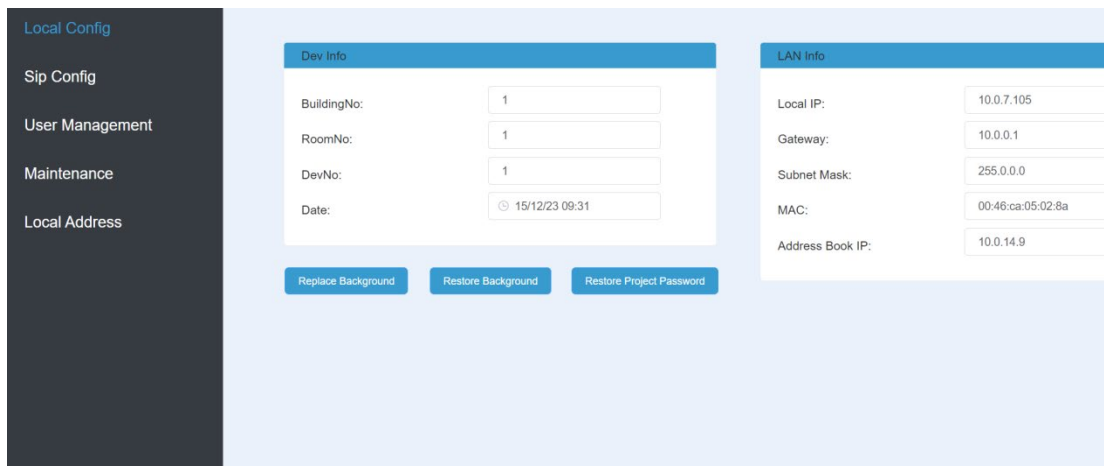

The image shows the 'Local Configuration' page. On the left is a dark sidebar with menu items: 'Local Config' (highlighted), 'Sip Config', 'User Management', 'Maintenance', and 'Local Address'. The main content area is divided into two panels. The 'Dev Info' panel has fields for 'BuildingNo:' (1), 'RoomNo:' (1), 'DevNo:' (1), and 'Date:' (15/12/23 09:31). The 'LAN Info' panel has fields for 'Local IP:' (10.0.7.105), 'Gateway:' (10.0.0.1), 'Subnet Mask:' (255.0.0.0), 'MAC:' (00:46:ca:05:02:8a), and 'Address Book IP:' (10.0.14.9). At the bottom are three buttons: 'Replace Background', 'Restore Background', and 'Restore Project Password'.

8.3 SIP Configuration Page

In the SIP configuration page, you can register the device to the SIP servers.

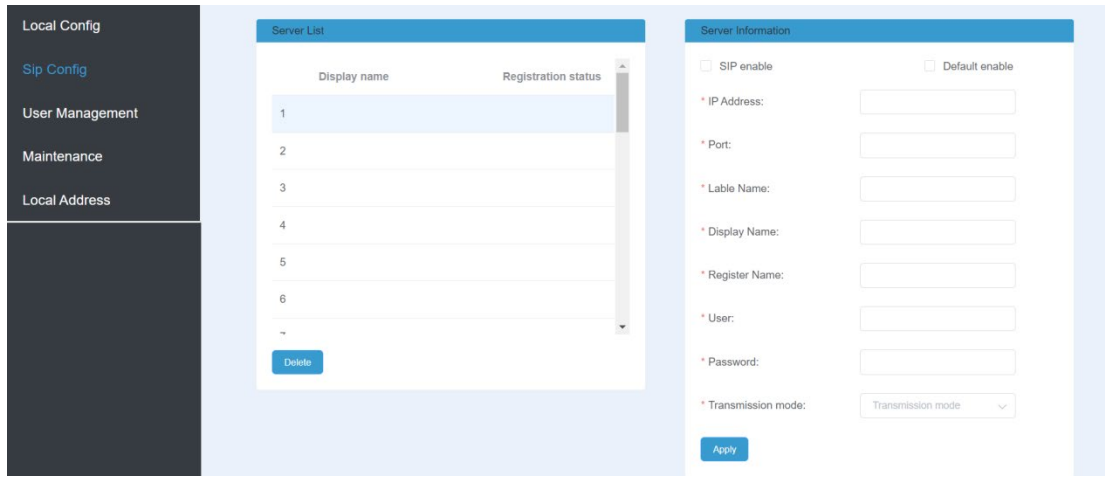

Remark:

The door panel support 30 SIP accounts, corresponding to 30 SIP servers.
 SIP server should be in the same network segment with the door panel.

8.4 User Management Page

In the user management page, you can click the [Edit] item to set the password and remarks.

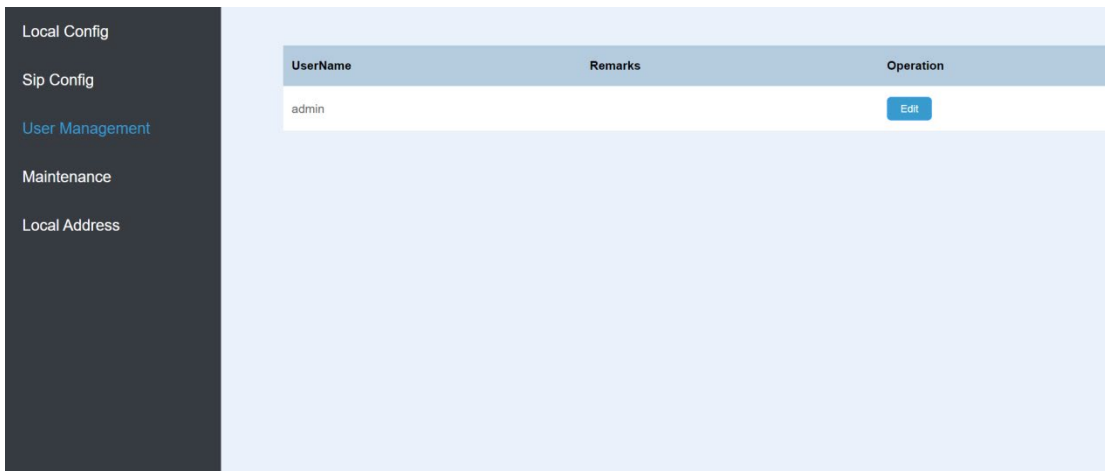

8.5 Maintenance Page

In the maintenance page, you can update the software version; you can also reboot the device.

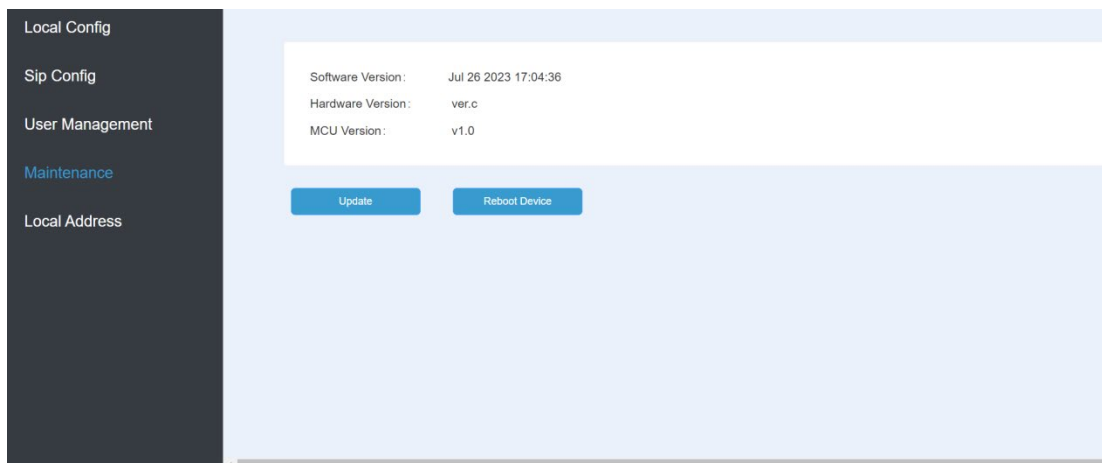

8.6 Local Address Page (Only for villa mode)

You can import a "sipbook.csv" file from your computer to add the contacts. The "sipbook.csv" file need to contain room name, call code and SIP server ip address. Additionally, the data should be entered starting from the second row onwards.

	A	B	C
1	name	idcode	ip
2	room1	01003	10.0.0.199
3	room2	01030	10.0.0.199
4	room3	01040	10.0.0.199
5			

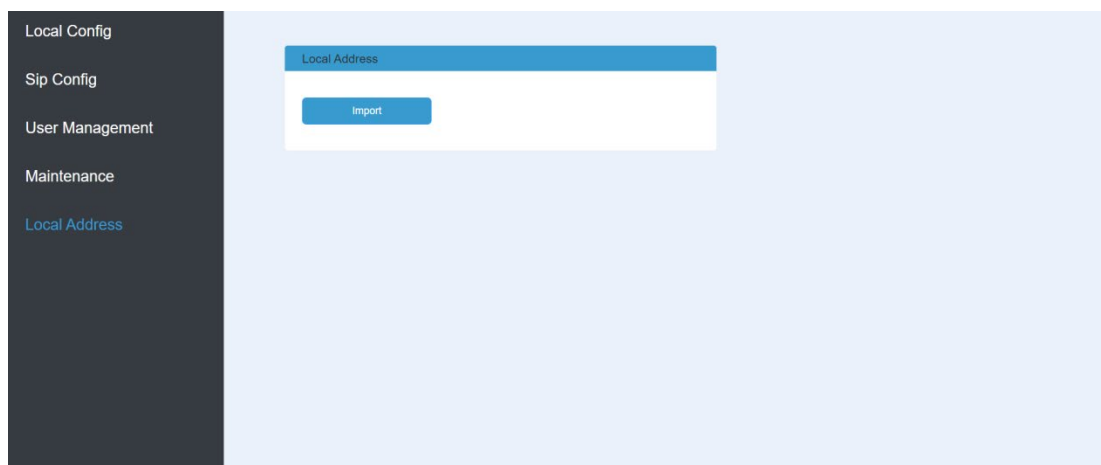

Remark:

- The file you import should be the "csv" format, and the file name should be "sipbook.csv". If the file format or file name is wrong, then the web will show wrong tips when uploading.
- The file you import should contain the column heading of "name", "idcode", "ip". If the column heading of "name", "idcode", "ip" are wrong, then the web will show wrong tips when uploading.
- The column heading of "ip" is the SIP server ip address.
- You can define the content starts from the second row based on the actual project needs.

Panasonic Corporation

1006 Kadoma, Kadoma City, Osaka 571-8501, Japan

<https://www.panasonic.com>

© Panasonic Corporation 2026

PNQP2049ZA P0126MG0